



Probes targeting novel stramenopiles

*Ramon Massana
Laure Guillou
Beatriz Díez
Carlos Pedrós-Alió*

Institut de Ciències del Mar, Barcelona, Spain

Marine picoeukaryotes

Ubiquitous and significant members of the plankton

Phototrophic: 10^3 - 10^4 cells ml⁻¹

Heterotrophic: 10^2 - 10^3 cells ml⁻¹

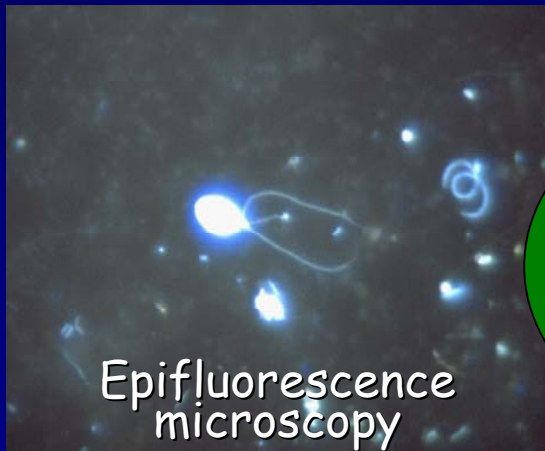

Observation and
count

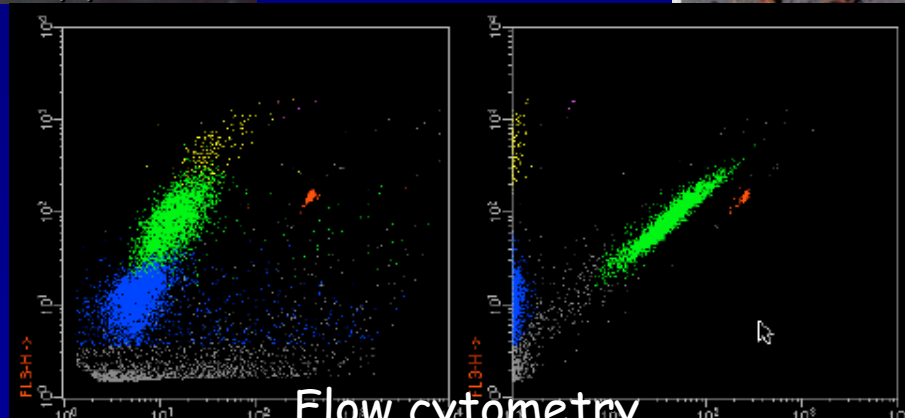
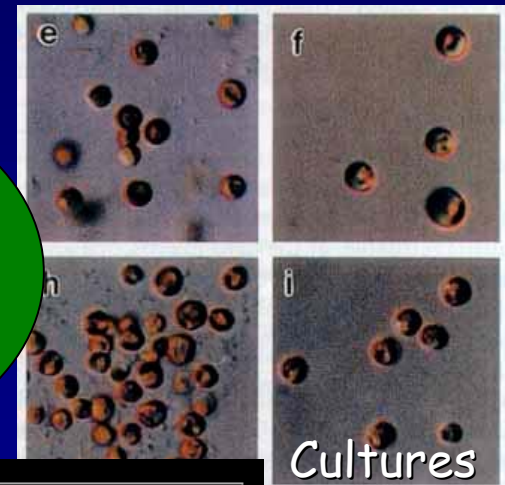

Genetic library of 18S rRNA genes

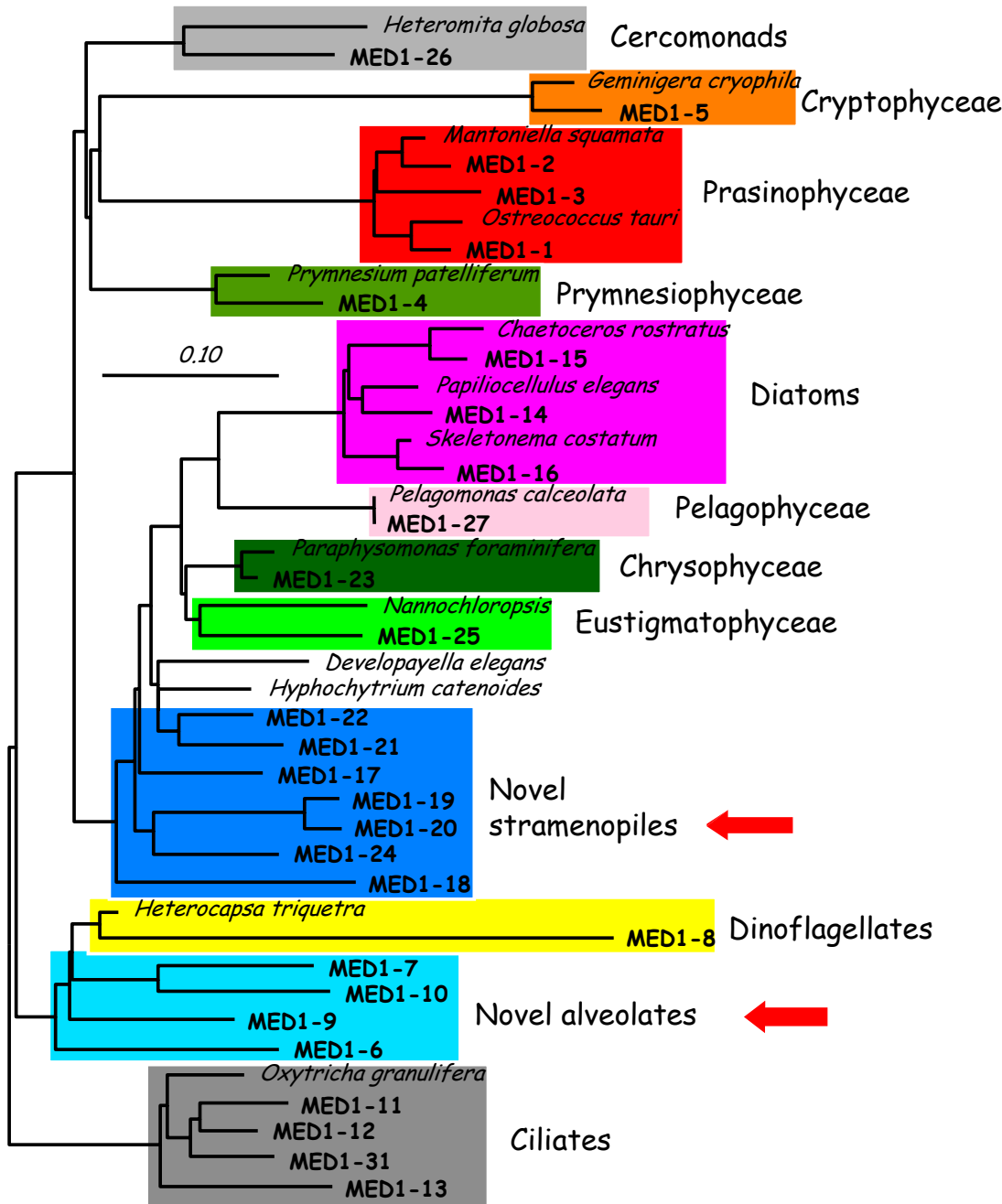

Sample analyzed
Alboran Sea (NW Med) - 5m
Fraction: 0.2 - 5 μ m

Novel groups are abundant and widespread

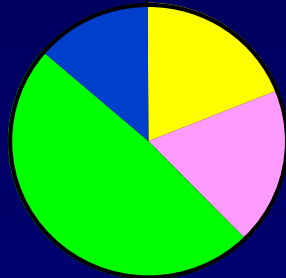

North Atlantic

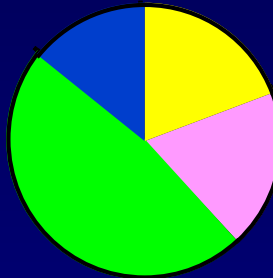

Mediterranean Open sea

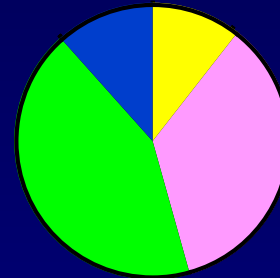

Mediterranean Coast

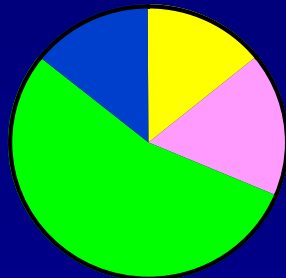

Equatorial Pacific

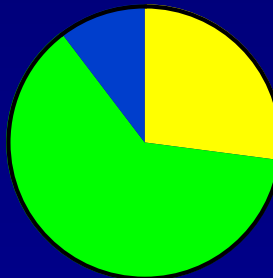

Antarctica

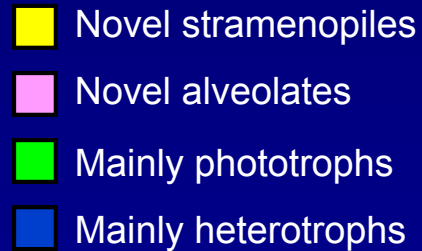

Díez et al. 2001
López-García et al. 2001
Moon van der Staay et al 2001

BL00921

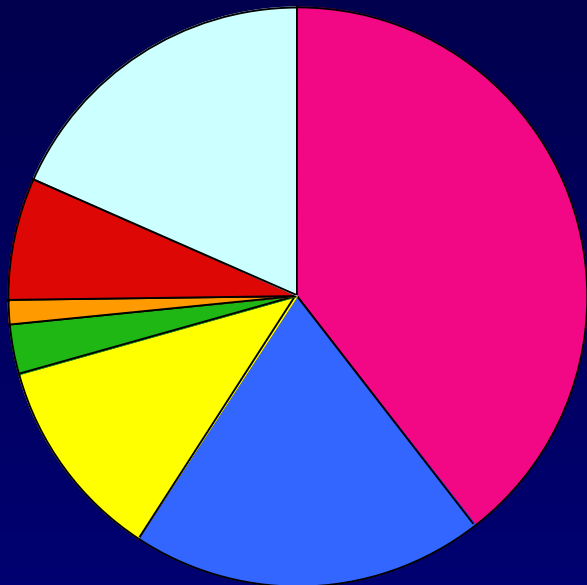

BL001221

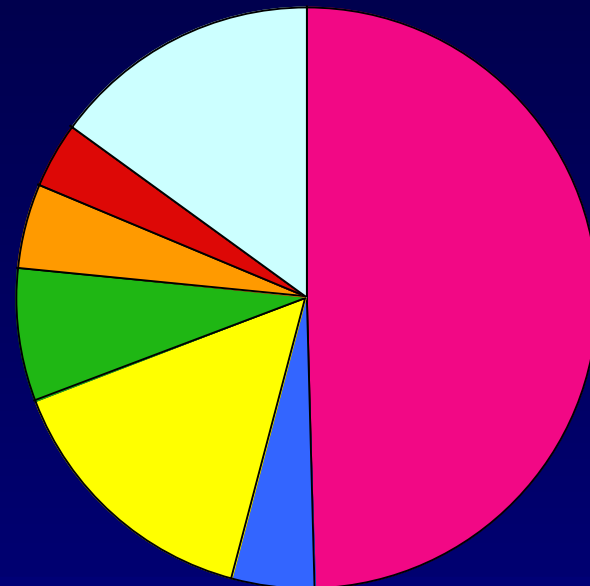

BL010320

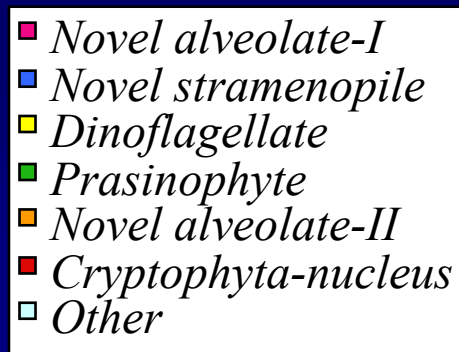
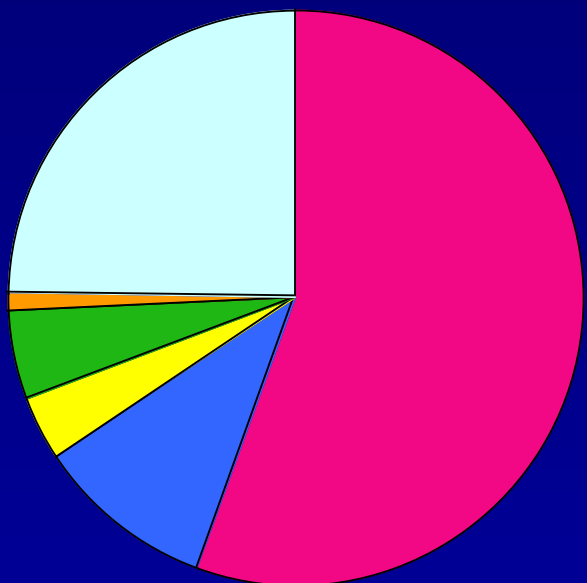

BL010625

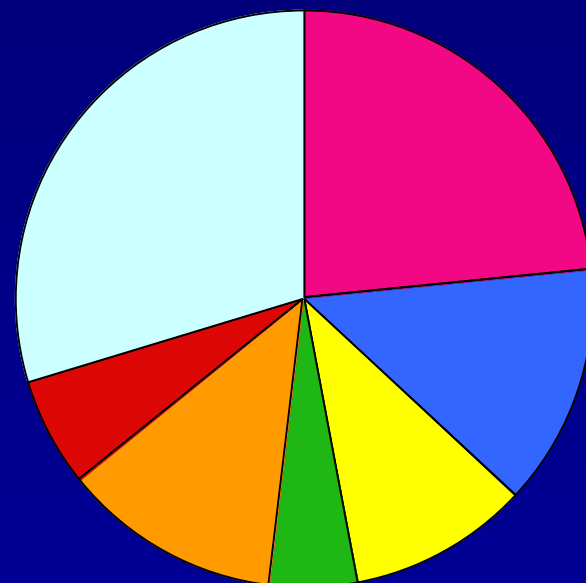

Novel stramenopiles
are very diverse

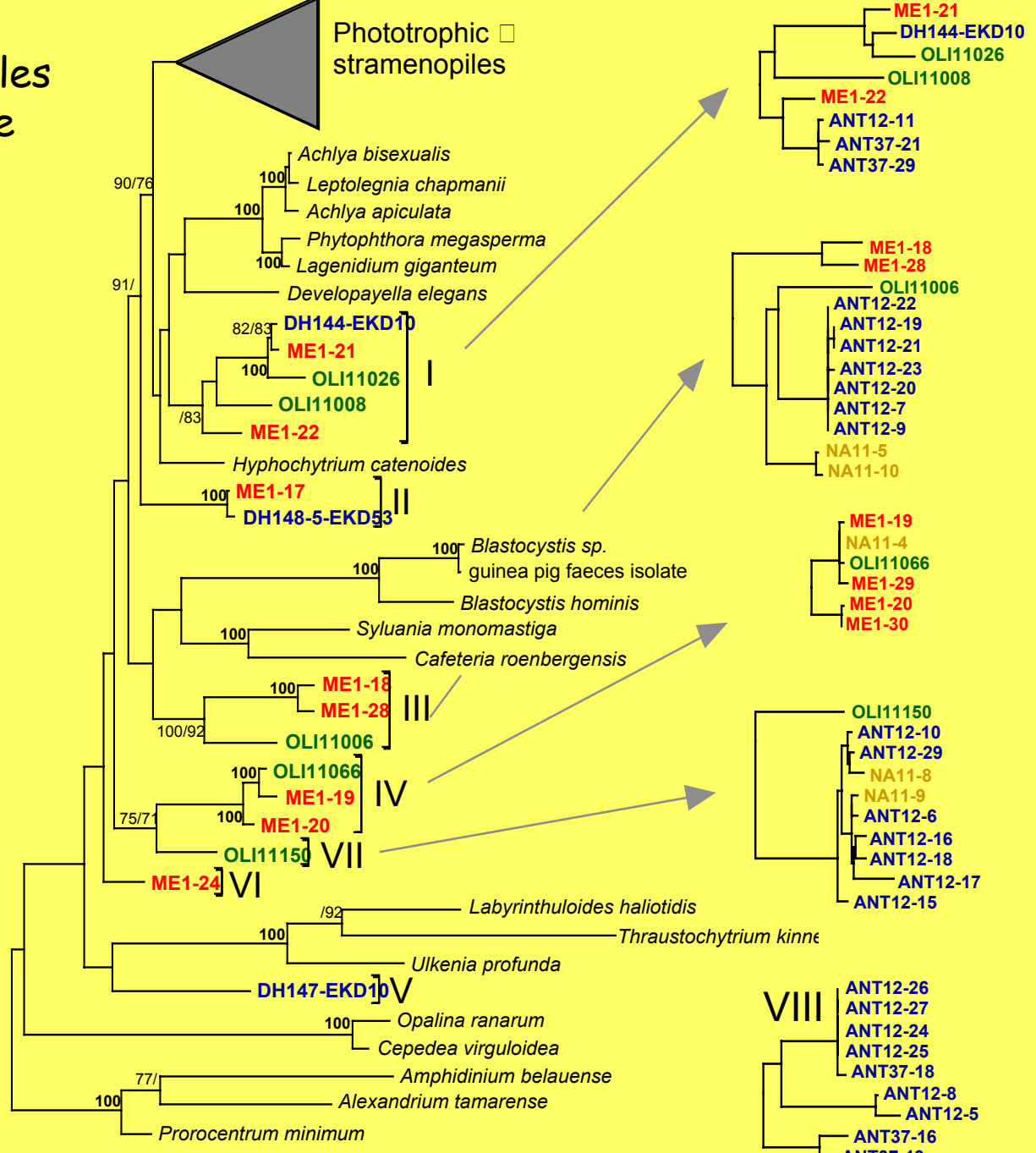

Distribution of clones inside clusters

	Mediterranean	North Atlantic	Antarctica	Eq Pacific	Antarctica-deep	SUM
I	2	0	4	2	1	9
II	1	0	0	0	1	2
III	3	4	7	1	0	15
IV	4	1	0	1	0	6
V	0	0	0	0	1	1
VI	2	0	1	0	0	3
VII	0	2	8	1	0	11
VIII	0	0	14	0	0	14
SUM	12	7	34	5	3	61

Probes for novel stramenopiles

846

NS3 ATTACCTTGGCCTCC-AAC

828

NS4 TACTTCGGTCTGCAAAACC

Cluster III

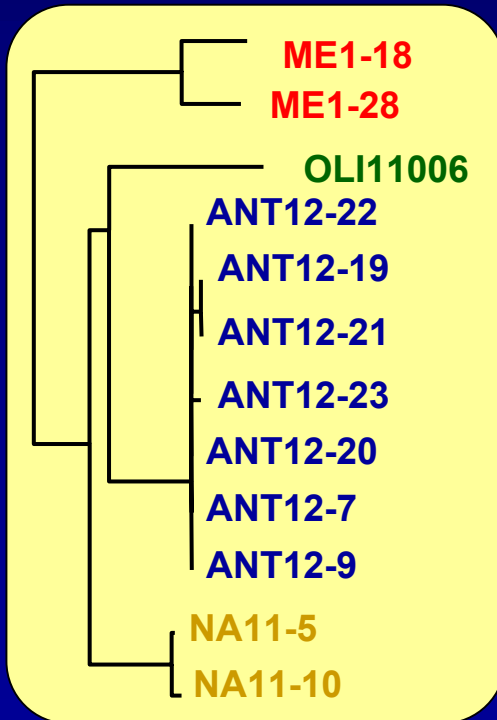

Cluster IV

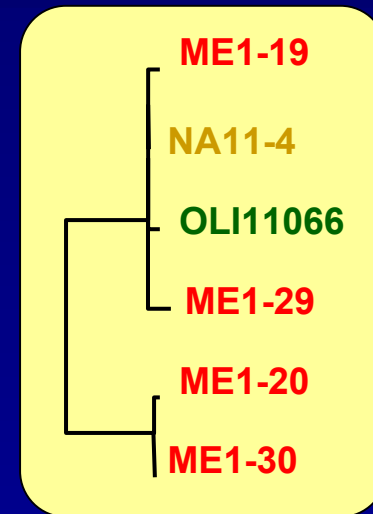

Detection of novel stramenopiles by FISH

Cultures used as negative controls:

- Prasinophyte
- Prymnesiophyte
- Cryptophyte
- Stramenopiles
 - Eustigmatophyte
 - Chrysoomonad
 - Bicosoecid

Cluster III

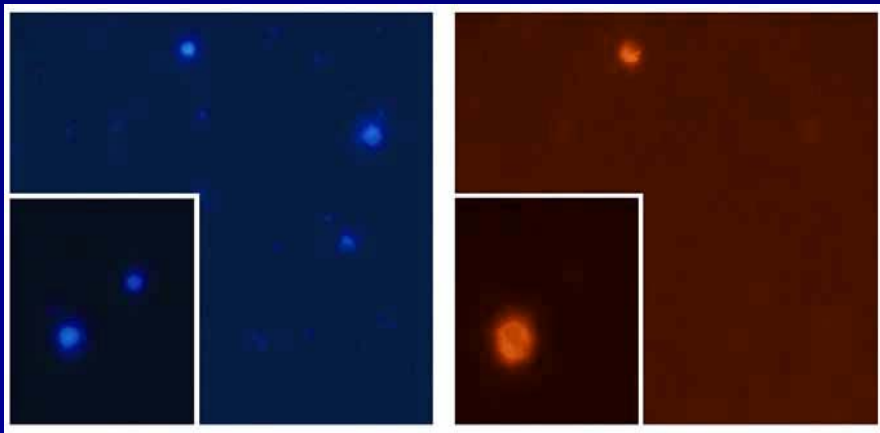

Cluster IV

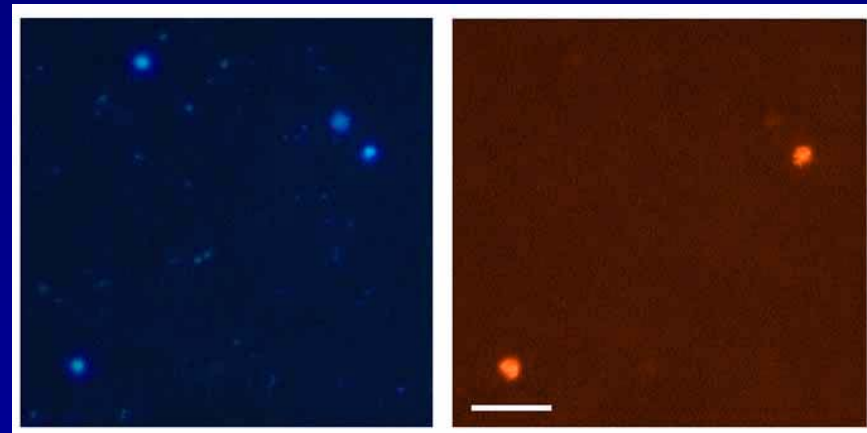

Dynamics during an enrichment culture

Blanes Coast sample
2 μm filtrate

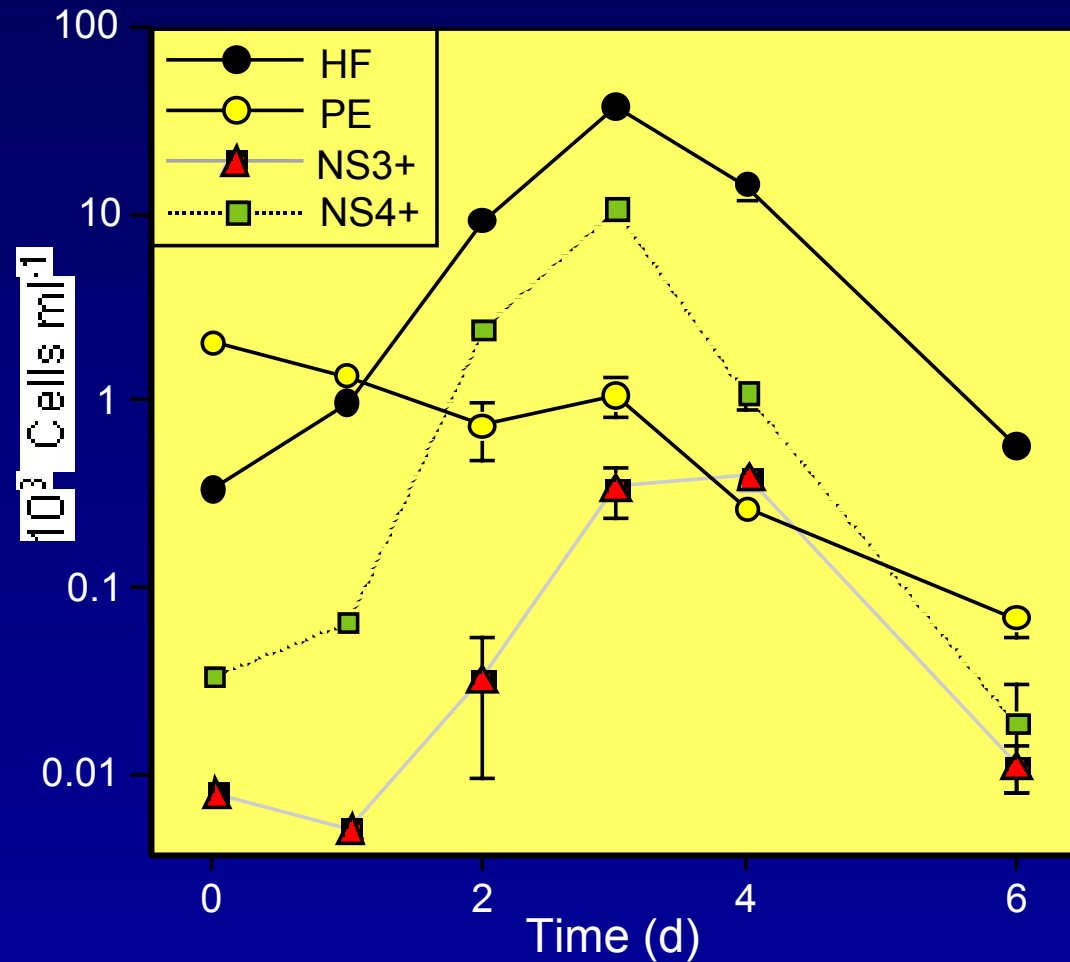

Experiment of bacterivory

Ingestion of FLB
 10^6 FLB ml⁻¹ in the enrichment culture for
2 hours

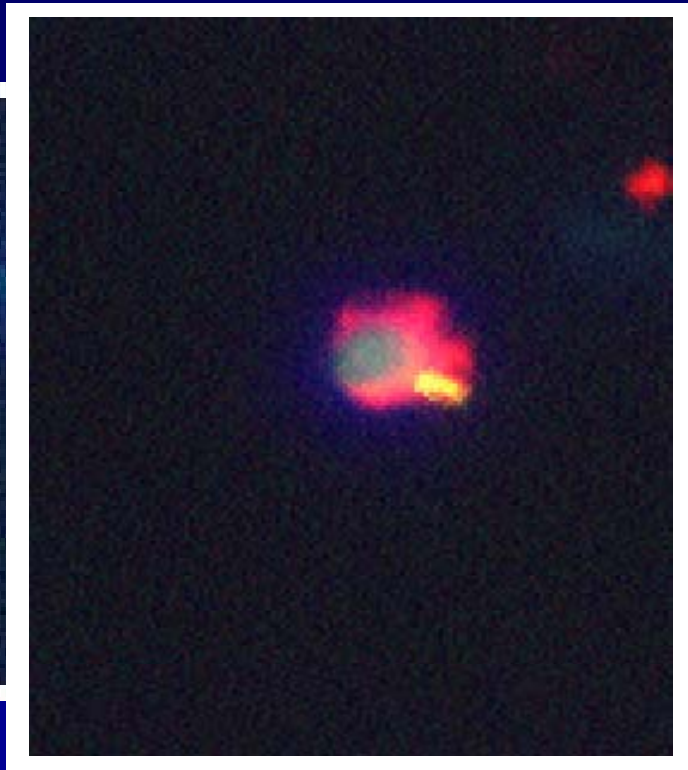

Abundance in situ - Blanes Coast

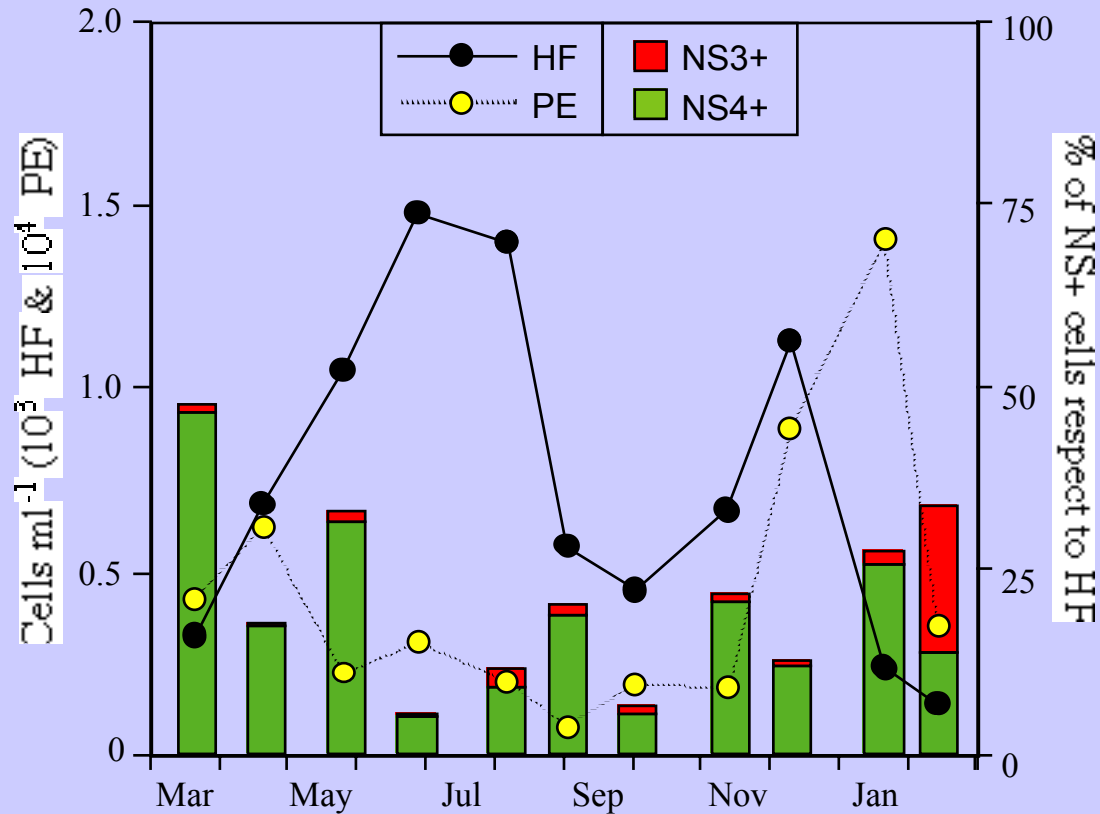

Seasonal average

- NS3+ cells: 12 cells ml⁻¹ (3% of HF)
- NS4+ cells: 120 cells ml⁻¹ (20% of HF)

Summary

Novel stramenopiles are . . .

- Abundant and widespread in genetic libraries of marine picoeukaryotes
- Phylogenetically very diverse, likely including different organisms
- Some are bacterivorous heterotrophic flagellates
- They comprise a significant fraction of natural HF assemblages

Future

Add partial sequences from other studies

Design more probes

Apply probes to natural samples

Libraries already analyzed (n=52)

Libraries already analyzed (n=52)			
	Mediterranean Sea	ME1	10
	Antartica	ANT12	22
	Antartica	ANT37	7
	Antartica	DH147	3
	North Atlantic	NA11	5
	Equatorial Pacific	OLI011	5

Libraries from PICODIV (n=120)			
	Mediterranean Sea	BL000921	12
		BL001221	4
		BL010320	5
		BL010625	8
	Equatorial Pacific	OLI	2
	English Channel	RA000412	13
		RA000609	5
		RA000907	2
		RA001219	7
		RA010412	6
		RA010516	7
		RA010613	10
		RD010517	1
	North Sea	He0003xx	1
		He000427	6
		He000803	6
		He001005	6
		HE001206	5
		HE010218	3
	North Atlantic	Or0004xx	11

Novel stramenopiles from Blanes

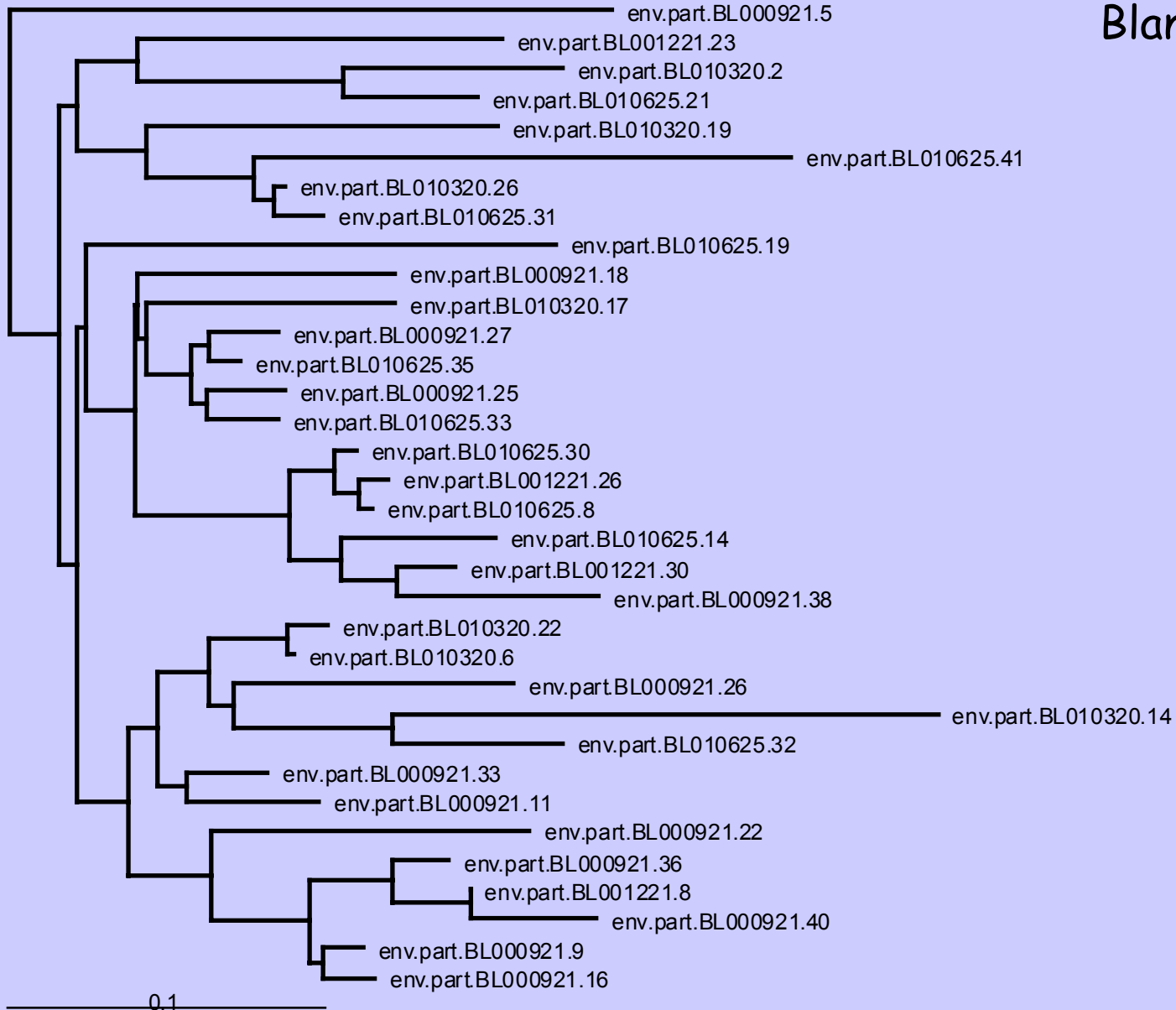

Libraries from other groups (n=71)		
Anoxic sediments - Dawson & Pace 2002. PNAS		
	BAQD	9
	BAQA	2
	BOLA	2
Guaymas Basin hydrothermal vent - Edgcomb et al. 2002		
	CS_E0	8
	C1_E0	6
	C2_E0	9
	C3_E0	9
	A3_E0	26

